

18 YEARS  
OF  
FOCUS



**Jicrade**  
**Nail Beauty**  
Rotary Burr

### SJ-03S

Small Barrel

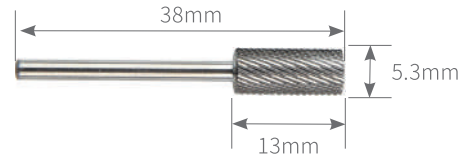
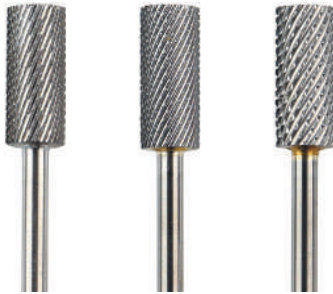

Item Code	Size	Coarseness
SJ-03S-F	Φ5.3x13	Fine
SJ-03S-M	Φ5.3x13	Medium
SJ-03S-C	Φ5.3x13	Coarse

### SJ-01S

Large Barrel

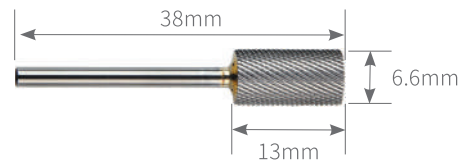

Item Code	Size	Coarseness
SJ-01S-F	Φ6.6x13	Fine
SJ-01S-M	Φ6.6x13	Medium
SJ-01S-C	Φ6.6x13	Coarse
SJ-01S-XC	Φ6.6x13	Extra Coarse
SJ-01S-2XC	Φ6.6x13	2 Extra Coarse
SJ-01S-3XC	Φ6.6x13	3 Extra Coarse
SJ-01S-4XC	Φ6.6x13	4 Extra Coarse

### SJ-01RS

Large Barrel with Smooth Top

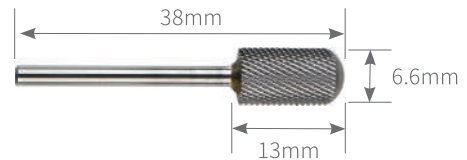

Item Code	Size	Coarseness
SJ-01RS-F	Φ6.6x13	Fine
SJ-01RS-M	Φ6.6x13	Medium
SJ-01RS-C	Φ6.6x13	Coarse
SJ-01RS-XC	Φ6.6x13	Extra Coarse
SJ-01RS-2XC	Φ6.6x13	2 Extra Coarse
SJ-01RS-3XC	Φ6.6x13	3 Extra Coarse
SJ-01RS-4XC	Φ6.6x13	4 Extra Coarse

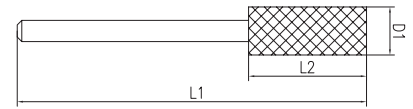

### For Natural Nail



Code	B0212-BRS
D1xL2(mm)	Φ2.2X12.5
L1(mm)	38

### Universal Use



Code	L0615A20
D1xL2(mm)	Φ6X15
L1(mm)	50

### For Ornaments Removal



Code	C0208XS	L0208XS	C0208S	M0208
D1xL2(mm)	Φ1.5x8	Φ1.5x8	Φ2x8	Φ2.3x8
L1(mm)	44.5	44.5	44.5	44.5

### For Under Nail Cleaning



Code	FA0214S	SJ-08S	L0312S	L0414B-P2S
D1xL2(mm)	Φ2.3x14	Φ2.3X14.5	Φ3X12.7	Φ4X13.5
L1(mm)	38	38	51	51

### For Cuticle

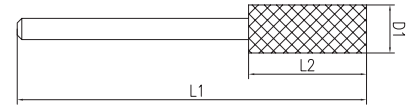

Code	PD-02X	PD-02	PD-03	H0103	SJ-21S	CN0205S	H0206S	CN0305S
D1xL2(mm)	Φ1.3x2.5	Φ1.3x6.5	Φ1.6x3	Φ1.6x3	Φ1.6x7	Φ2x5	Φ2.3x6	Φ2.8x5.3
L1(mm)	44.5	44.5	44.5	44.5	38	44.5	44.5	44

**Ball Shape**

Code	D010S	D016S	D023S	D030S	D040S	D050S	D060S
D1xL2(mm)	Φ1.0	Φ1.6	Φ2.3	Φ3.0	Φ4.0	Φ5.0	Φ6.0
L1(mm)	44.5	44.5	44.5	33	39.5	42	42

**Tree Shape**

Code	F0615-P3S-XF	F0615-P3S-F	F0615-P3S-M	F0615-P3S-C	F0615-XF	F0615-F	F0615-M	F0615-C
D1xL2(mm)	Φ6X14.5	Φ6X14.5	Φ6X14.5	Φ6X14.5	Φ6X14.5	Φ6X14.5	Φ6X14.5	Φ6X14.5
L1(mm)	52.5	52.5	52.5	52.5	53	53	53	53

**Flame Shape**

Code	H0615-P2S-C	H0615-P2S-0.5XC	H0615-P2S-XC	H0615A-P5S-F	H0615A-P5S-M	H0615A-P5S-C
D1xL2(mm)	Φ6X14.5	Φ6X14.5	Φ6X14.5	Φ6X14.5	Φ6X14.5	Φ6X14.5
L1(mm)	52.5	52.5	52.5	50.5	50.5	50.5

**Cone Radius Shape**

Code	L0715-P2S-F	L0715-P2S-M	L0715-P2S-C	L0715-P2S-XC	L0715-P2S-2XC	L0715-P2S-3XC	LD0715B-P3S-XC	LD0715B-P3S-2XC
D1xL2(mm)	Φ6.8X15	Φ6.8X15	Φ6.8X15	Φ6.8X15	Φ6.8X15	Φ6.8X15	Φ6.8X15	Φ6.8X15
L1(mm)	45	45	45	45	45	45	45	45

### For Pedicure

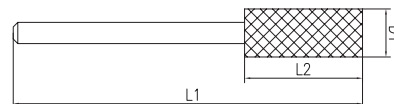

Code	L358S	FA0208	D0202P	D0504P	D0605P	C0613
D1xL2(mm)	Φ1.65x8	Φ2.0x8.2	Φ2.3	Φ5.0	Φ6.0	Φ6x13
L1(mm)	44.5	44.5	44.5	40	43	51



Code	F0513B-P2S	F0513-P7S	F0615A-P7S	H0413	H0615AP	H0615PS	L0413	L0413A-P7S	LD0714B-P2S
D1xL2(mm)	Φ5x13	Φ5x13	Φ6x14.5	Φ4x13	Φ6x14.5	Φ6x14.5	Φ4.5x13	Φ4.5x13	Φ6.8x14.5
L1(mm)	51	49	50	44.5	52.5	53	50.5	49	52.5



Code	PD-01-1.8	PD-01-2.3	PD-01-2.8	PD-01-3.0
D1(mm)	Φ1.8	Φ2.3	Φ2.8	Φ3.0
L1(mm)	45	45	45	45

Code	PD-01X-1.8	PD-01X-2.3	PD-01X-2.8	PD-01X-3.0
D1(mm)	Φ1.8	Φ2.3	Φ2.8	Φ3.0
L1(mm)	45	45	45	45

### BM0715-BRS

5 in 1

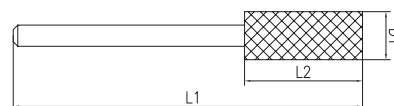

Item Code	D1XL2(mm)	Coarseness
BM0715-BRS-F	Φ6.8X15	Fine
BM0715-BRS-M	Φ6.8X15	Medium
BM0715-BRS-C	Φ6.8X15	Coarse
BM0715-BRS-XC	Φ6.8X15	Extra Coarse
BM0715-BRS-2XC	Φ6.8X15	2 Extra Coarse

### Three coarseness in one burr

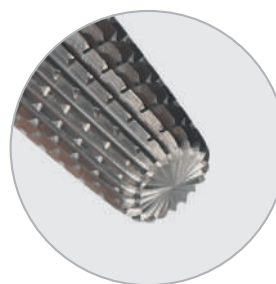
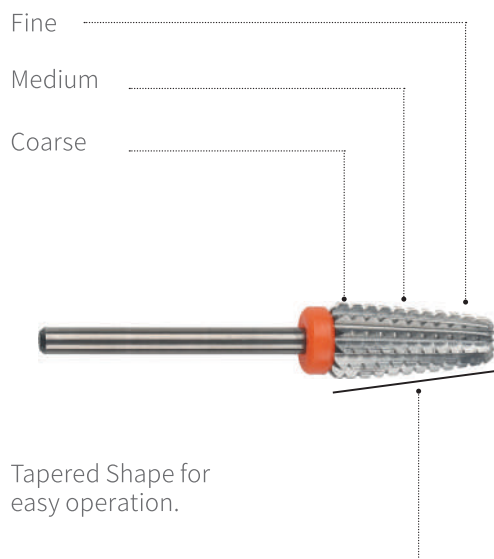

- ① Radius rim, no sharp edge, no hurt.
- ② Teeth on radius rim, for cuticle use.
- ③ Two-way

# AMR0715-D4S

Super Clean, D4S style!



**Normal Bits**  
Dust flies all directions



**New D4S Bits**  
Dust run one direction



- 01 Clean**  
Chips run towards one direction
- 02 Safe**  
Shaft of bit goes inside the collet instead of being pulled out
- 03 Extra Function**  
With teeth on radius rim
- 04 No Hurt**  
Radius rim, no sharp edge, no hurt
- 05 Stable**  
Sharp, stable and durable at high RPM



Item Code	Coarseness
AMR0715-D4S-2XF	2 Extra Fine
AMR0715-D4S-XF	Extra Fine
AMR0715-D4S-F	Fine
AMR0715-D4S-M	Medium
AMR0715-D4S-C	Coarse
AMR0715-D4S-XC	Extra Coarse
AMR0715-D4S-2XC	2 Extra Coarse
AMR0715-D4S-3XC	3 Extra Coarse

# AR0613-D4S

Super Clean, D4S style!



**Normal Bits**  
Dust flies all directions



**New D4S Bits**  
Dust run one direction

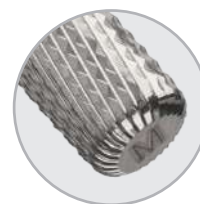

- 01 Clean**  
Chips run towards one direction
- 02 Safe**  
Shaft of bit goes inside the collet instead of being pulled out
- 03 Extra Function**  
With teeth on radius rim
- 04 No Hurt**  
Radius rim, no sharp edge, no hurt
- 05 Stable**  
Sharp, stable and durable at high RPM



Item Code	Coarseness
AR0613-D4S-XF	Extra Fine
AR0613-D4S-F	Fine
AR0613-D4S-M	Medium
AR0613-D4S-C	Coarse
AR0613-D4S-XC	Extra Coarse
AR0613-D4S-2XC	2 Extra Coarse
AR0613-D4S-3XC	3 Extra Coarse
AR0613-D4S-4XC	4 Extra Coarse



# BM0616-RD8

Mixed Cuts Multi-Functions

**New!**

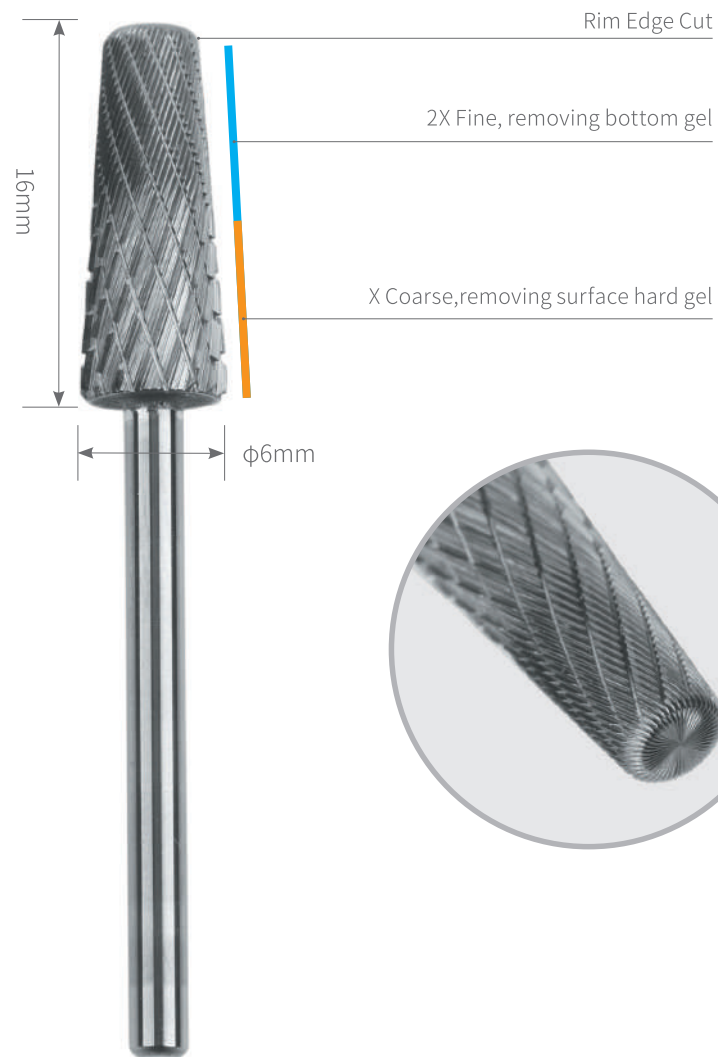

Item code	Size	Coarseness
BM0616-RD8-M	φ6x16	Medium
BM0616-RD8-XC	φ6x16	Extra Coarse

# BM0616-RD9

Mixed Cuts Multi-Functions

**New!**

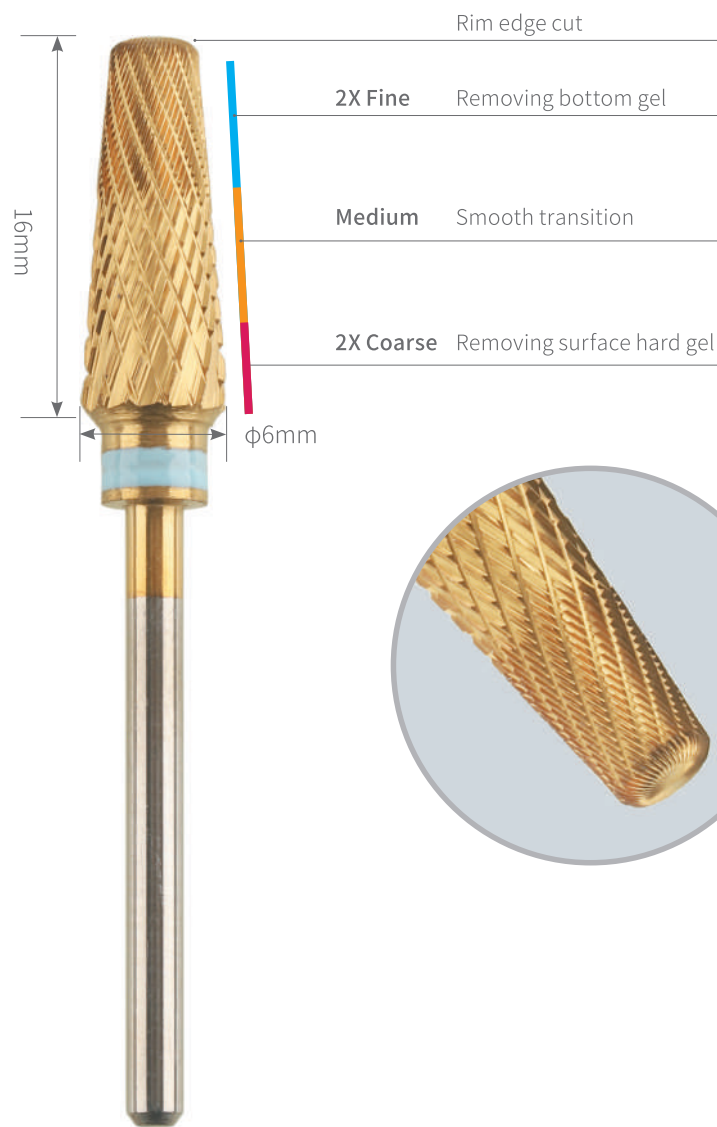

Item code	Size	Coarseness
BM0616-RD9	φ6x16	Mixed Cut



### Optional Finish Types



(S) ◆ Silver coating



(G) ◆ Golden coating



(Tin) ◆ Titanium coating



(B) ◆ Blue coating



(Q) ◆ Rainbow coating



(H) ◆ Black coating



(Z) ◆ Purple coating

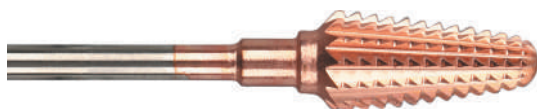

(RG) ◆ Rose gold coating

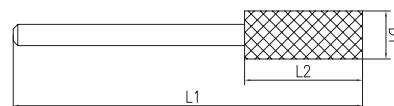

### Barrel $\phi 6.6$



Code	A0713T-F	A0713T-M	A0713T-C	A0713T-XC	A0713T-2XC	A0713T-3XC
D1xL2(mm)	$\phi 6.6 \times 13$	$\phi 6.6 \times 13$	$\phi 6.6 \times 13$	$\phi 6.6 \times 13$	$\phi 6.6 \times 13$	$\phi 6.6 \times 13$
L1(mm)	38	38	38	38	38	38

### Barrel $\phi 6$



Code	A0613T-F	A0613T-M	A0613T-C
D1xL2(mm)	$\phi 6 \times 13$	$\phi 6 \times 13$	$\phi 6 \times 13$
L1(mm)	38	38	38

### Barrel Round Top with Cut



Code	C0713T-F	C0713T-M	C0713T-C
D1xL2(mm)	$\phi 6 \times 13$	$\phi 6 \times 13$	$\phi 6 \times 13$
L1(mm)	38	38	38

### Barrel Smooth Round Top



Code	C0713TF-F	C0713TF-M	C0713TF-C	C0713TF-XC	C0713TF-2XC	C0713TF-3XC
D1xL2(mm)	$\phi 6.6 \times 13$	$\phi 6.6 \times 13$	$\phi 6.6 \times 13$	$\phi 6.6 \times 13$	$\phi 6.6 \times 13$	$\phi 6.6 \times 13$
L1(mm)	38	38	38	38	38	38

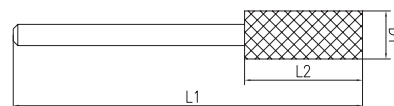

### For Cuticle

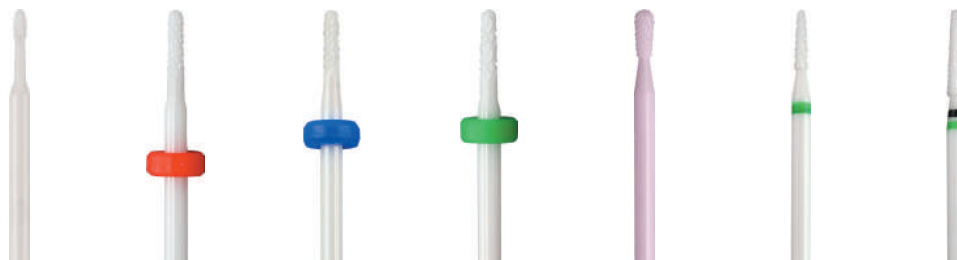

Code	PD-03T	C0207T-F	C0207T-M	C0207T-C	CN0205T	L371T	L358T
D1xL2(mm)	Φ1.5x3.5	Φ1.6x7.0	Φ1.6x7.0	Φ1.6x7.0	Φ2.0x5.0	Φ1.8x8.0	Φ2.3x12.0
L1(mm)	44.5	38	38	38	44.5	44.5	44.5

### For Under Nail



Code	SJ-15T	C0214T	FA0214T	L0418T
D1xL2(mm)	Φ2.3x13.5	Φ2.3x14.0	Φ2.3x14.0	Φ4.5x18.0
L1(mm)	38	44.5	38	49

### For Pedicure



Code	H0615TC	D0605TB	F1025T
D1xL2(mm)	Φ6.0x14.5	Φ6.0	Φ10.0x25.0
L1(mm)	52	42.5	60

### Universal



Code	L0613TB20-F	L0613TB20-M
D1xL2(mm)	Φ6.0x13.0	Φ6.0x13.0
L1(mm)	51	51

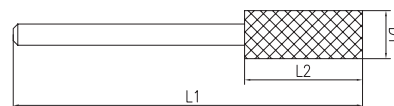

### Ball



Code	D010T	D0202T	D0303T-F	D0303T-M	D0303T-C
D1xL2(mm)	Φ1.0	Φ2.0	Φ3.0	Φ3.0	Φ3.0
L1(mm)	44.5	38	44.5	44.5	44.5

### Long Tree



Code	FA0620T-F	FA0620T-M	FA0620T-C
D1xL2(mm)	Φ6.0x20.0	Φ6.0x20.0	Φ6.0x20.0
L1(mm)	50	50	50

### Flame



Code	H0615T-XF	H0615T-F	H0615T-M	H0615T-C	H0615TB-XF	H0615TB-F	H0615TB-M	H0615TB-C	H0615TB-XC
D1xL2(mm)	Φ6.0x14.5	Φ6.0x14.5	Φ6.0x14.5	Φ6.0x14.5	Φ6.0x14.5	Φ6.0x14.5	Φ6.0x14.5	Φ6.0x14.5	Φ6.0x14.5
L1(mm)	49.5	49.5	49.5	49.5	52	52	52	52	52

### Cone Radius End



Code	L0413T-F	L0413T-M	L0413T-C	L0413TB-F	L0413TB-M	L0413TB-C
D1xL2(mm)	Φ4.5x13.0	Φ4.5x13.0	Φ4.5x13.0	Φ4.5x13.0	Φ4.5x13.0	Φ4.5x13.0
L1(mm)	40	40	40	40	40	40



Code	LD0611TB-F	LD0611TB-M	LD0611TB-C	L0614TB-F	L0614TB-M	L0614TB-C	L0614T-F	L0614T-M	L0614T-C
D1xL2(mm)	Φ5.8x11.0	Φ5.8x11.0	Φ5.8x11.0	Φ6.0x14.0	Φ6.0x14.0	Φ6.0x14.0	Φ6.0x14.0	Φ6.0x14.0	Φ6.0x14.0
L1(mm)	48	48	48	51	51	51	51	51	51

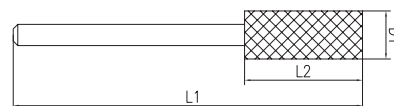

### Diamond Bit



Code	B0105D	B0207D	B0306D	B0408D	B0509D	D-2	D-1
D1xL2(mm)	Φ0.9x5.4	Φ2x7	Φ3.2x6.3	Φ4.3x7.6	Φ5x9	Φ5x13	Φ6.6x13
L1(mm)	44	45	44	45	44.5	38	38



Code	BM0310D	BM0307D	BM0509D	BM0814D	AMD0918D
D1xL2(mm)	Φ2.5x10	Φ3x7	Φ5.2x9.2	Φ8x14	Φ9x18
L1(mm)	50	44.5	44	54	55



Code	C016070D	C0210D	C0407D	C0412D	CN0205D	CN0608D	CN0912D
D1xL2(mm)	Φ1.6x7	Φ2.6x10	Φ3.5x7	Φ3.9x12	Φ2.6x5.1	Φ6x8	Φ9x12
L1(mm)	44.5	44.5	44.5	44.5	44.5	52	52

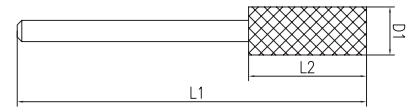

### Diamond Bit



Code	D010D	D015D	D018D	D023D	D030D	D040D	D050D
D1xL2(mm)	Φ1.0	Φ1.5	Φ1.8	Φ2.3	Φ3.0	Φ4.0	Φ5.0
L1(mm)	44.5	44.5	45.5	44.5	45	45	45



Code	FA027090D	D-4	F0407D
D1xL2(mm)	Φ2.7X9	Φ2.7X14	Φ4X7
L1(mm)	45	40	44.5

Code	H0108D	H018105D	H018105SD	H0210SD	H0210D
D1xL2(mm)	Φ1.4X8.3	Φ1.8X10.5	Φ1.8X10.5	Φ2.3X10	Φ2.5X9
L1(mm)	44.5	44.5	44.5	44	44.5



Code	GA010085D	GD014025D	GD018045D	GD0204D	GD0307D	GD033071D	D-6	D-5	D-5B	G0815D
D1xL2(mm)	Φ1X8.5	Φ1.4X2.5	Φ1.8X4.5	Φ2.1X4.0	Φ2.7X7.3	Φ3.3X7.1	Φ4.5X9	Φ5X10	Φ6X13	Φ8X15
L1(mm)	45	44.5	42.5	44.5	48	44.5	34	34.8	37.8	50



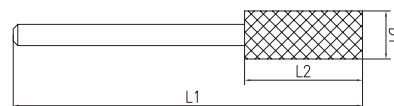

### Diamond Bit



Code	L0108D	L0110D	L016100D	L0210D	L0307D	L033100D	LD065125D
D1xL2(mm)	Φ1.4X8.2	Φ1.4X10	Φ1.6X10	Φ2.3X10	Φ3X7	Φ3.3X10	Φ6.5X12.5
L1(mm)	44.5	44.5	48	44.5	44.5	44.5	44



Code	M0307D	D-3	MD0412D
D1xL2(mm)	Φ3X7	Φ5X15	Φ4.2X12
L1(mm)	44.5	40	44.5



Code	MN0807D	D-7
D1xL2(mm)	Φ8	Φ10
L1(mm)	44.5	34



Code	N014014D
D1xL2(mm)	Φ1.4X1.4
L1(mm)	44.5

# Pedicure Diamond Burr

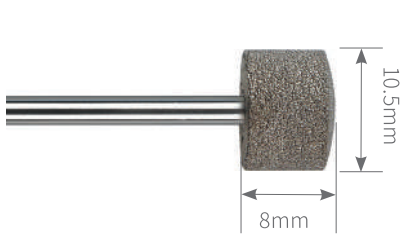

**C1108D**

Φ10.5x8mm

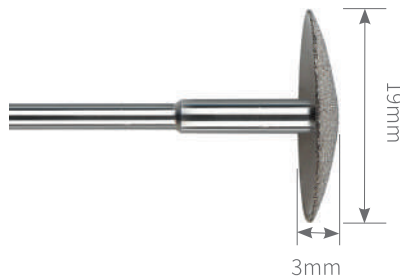

**C1903D**

Φ19x3mm

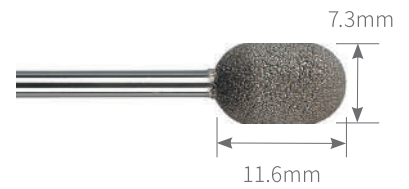

**CD0712D**

Φ7.3x11.6mm

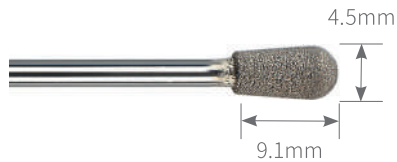

**CN0509D**

Φ4.5x9.1mm

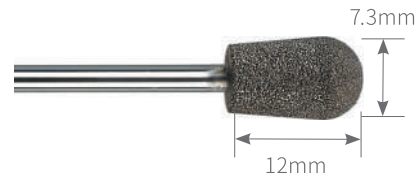

**CN0712D**

Φ7.3x12

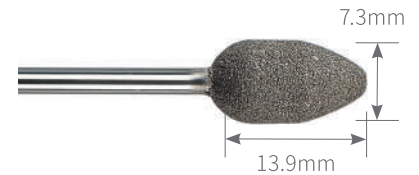

**FAD0714D**

Φ7.3x13.9mm

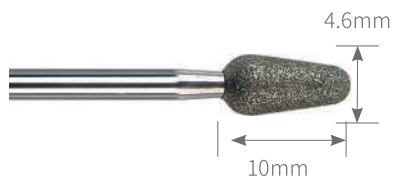

**LD0510D**

Φ4.6x10mm

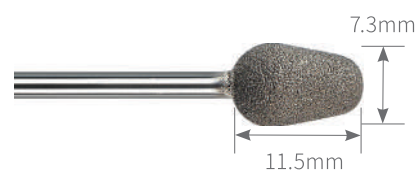

**LD0712D**

Φ7.3x11.5

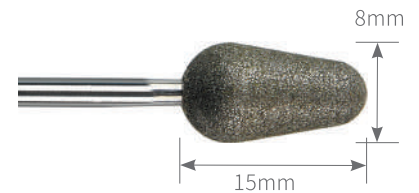

**D-8**

Φ8x15

## Optional Diamond Grits



Extra Coarse



Coarse



Medium

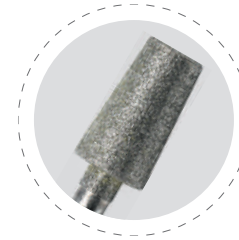

Fine



Extra Fine

## Optional Color Rings



Extra Coarse



Coarse



Medium



Fine

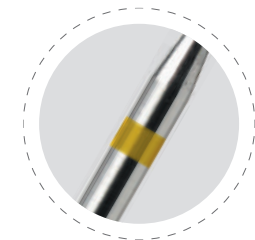

Extra Fine

### Sanding Band

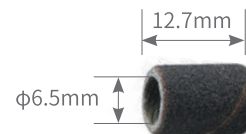

SJ-170A  
Brown Sanding Band



SJ-170B  
Black Sanding Band



SJ-170Z  
Zebra Sanding Band



SJ-170G  
Green Sanding Band



SJ-170Y  
Yellow Sanding Band



SJ-170P  
Purple Sanding Band

### Mandrel



SJ-20  
Steel



SJ-20G  
Golden Coated



SJ-20-2  
Flexible



SJ-20-3  
Tungsten Carbide



SJ-20-4  
Rubber

### Optional Package



# SJ-180

Sanding Cap



Item Code	Size (ΦxL)	Coarseness
SJ-180-5	Φ5x11	Coarse, Medium, Fine
SJ-180-7	Φ7x13	Coarse, Medium, Fine
SJ-180-10	Φ10x15	Coarse, Medium, Fine
SJ-180-13	Φ13x19	Coarse, Medium, Fine
SJ-180-16	Φ16x25	Coarse, Medium, Fine

# SJ-180M

Rubber Mandrel



Item Code	Size (ΦxL)
SJ-180M-5	Φ5x11
SJ-180M-7	Φ7x13
SJ-180M-10	Φ10x15
SJ-180M-13	Φ13x19
SJ-180M-16	Φ16x25

## Sanding Paper



**SDC-15**  
 Φ15mm  
 Coarse, Medium, Fine



**SDC-20**  
 Φ20mm  
 Coarse, Medium, Fine



**SDC-25**  
 Φ25mm  
 Coarse, Medium, Fine



**SDC-35**  
 Φ35mm  
 Coarse, Medium, Fine

## Mandrel



**SDM-15**  
 Φ15mm



**SDM-20**  
 Φ20mm



**SDM-25**  
 Φ25mm



**SDM-35**  
 Φ35mm



**SDM2-15**  
 Φ15mm



**SDM2-20**  
 Φ20mm



**SDM2-25**  
 Φ25mm



**SDM2-35**  
 Φ35mm



# SFF01

## Sanding Foot File

- ◆ **Stainless steel handle**  
Provides smooth and comfortable hand feel.
- ◆ **Replaceable sanding paper**  
Two grits, waterproof and no peeling.

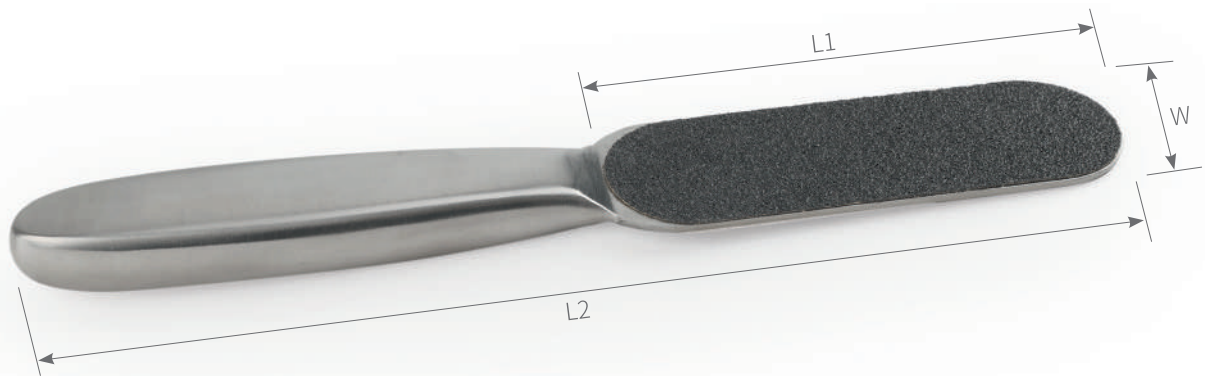

Code	W	L1	L2
SFF01-34	34mm	106mm	215mm



## Silicone Burr

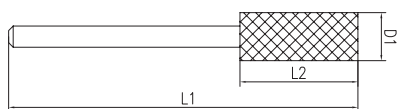

- Coarse
- Medium
- Fine



Code	G0412K	GA0516K	G0616K	F0616K
D1xL2(mm)	φ4x12	Φ5x16	Φ6x16	Φ6x16
L1(mm)	44	48	48	48



Code	F0720K	G1020K	F1024K	C1517K
D1xL2(mm)	φ7x20	Φ10x20	Φ10x24	Φ15x17
L1(mm)	53	53	57	52



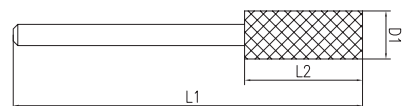

**Stone Bit for Natural Nail**

Code	A0206GC	A025080PA	AM0206PA	AM032060GC	AM035100GC	AM0412PA	C1517GCH	D0303PA
D1xL2(mm)	Φ2X6	Φ2.5X8	Φ2X6	Φ3.2X6	Φ3.5X10	Φ4X12	Φ15X17	Φ3
L1(mm)	42.5	0	42.5	44	47	47	54	40.5



Code	D0404PA	D0505PA	D0606GC	FA0517PA	G0407PA	GD035072PA	H0308PA	L0412BA
D1xL2(mm)	Φ4	Φ5	Φ6	Φ5X17	Φ4X7	Φ3.5X7.2	Φ3X8	Φ4X12
L1(mm)	41.5	41.5	41	55	42.5	45	46	47

## Nail Polishing



Code	SY-05
Size	Φ6X14.5
Material	Felt



Code	B-3
Size	Φ10X18
Material	Felt

## Nail Cleaning

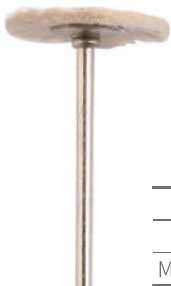

Code	T-01
Size	Φ22
Material	Goat Hair



Code	SY-02S
Size	Φ6.6
Material	Nylon



Code	SY-02
Size	Φ11
Material	Nylon

## Bit Cleaning



Code	BBS05
Size	20X60
Material	Nylon



Code	BBS16
Size	20X60
Material	Brass Wire

### NCK01

Natural Nail Care Kit

- 01 Push Cuticle
- 02 Remove Callus
- 03 Smooth Natural Nail
- 04 Cut Line Repair
- 05 Remove Cuticle
- 06 Clean



### NCK02

Gel Removing Kit

- 01 Remove Gel (Narrow Area)
- 02 Remove Gel (Quick Removing)
- 03 Smooth Under Nail
- 04 Remove Decoration
- 05 Clean



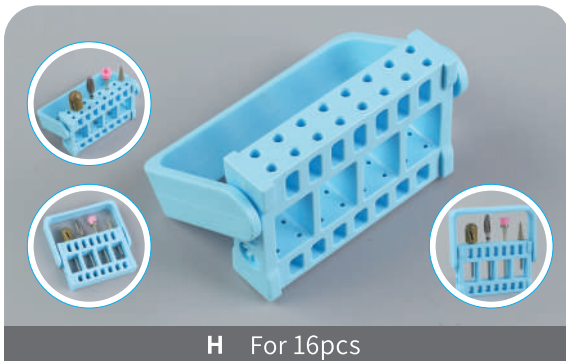
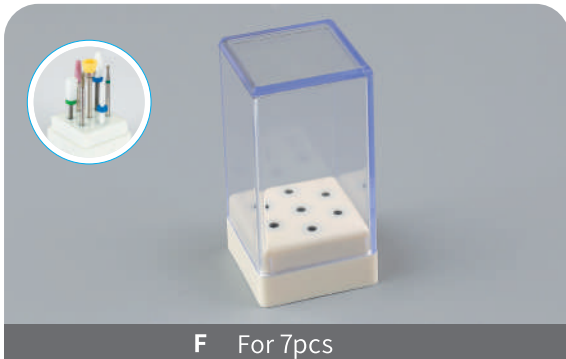



## WUXI JICRADE TECH CO.,LTD.

Unit D-21,288-1101 Zhongshan Road,Wuxi,Jiangsu,China

PC: 214400

Tel: +86-510-85755198

Mobile: +86-135 0616 0675

E-mail: [ji@jicrade.com](mailto:ji@jicrade.com)